

Data Sheet



Article number: 03556020

Description: Fluro hydraulic rod end FS 20N

Measures

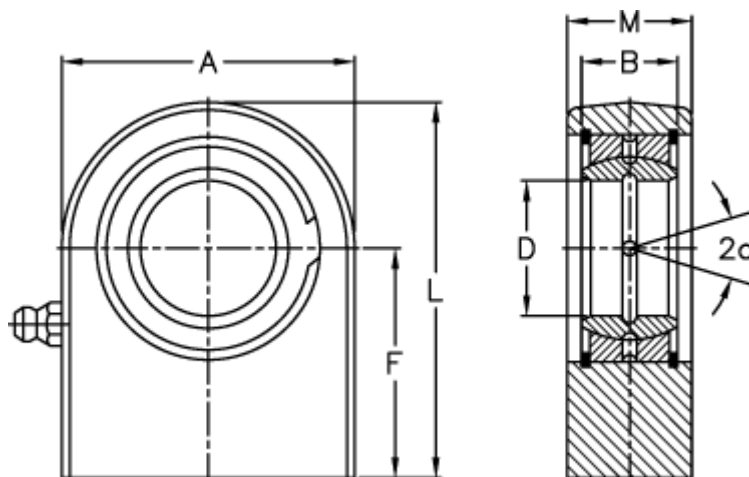

A	= 50	Static load C0 (kN) = 67
a (degrees)	= 9	Weight = 325
B	= 16	
D	= 20	
Dynamic load C (kN)	= 30	
F	= 38	
L	= 63	
M	= 19	